

## VALVOLE SERIE 70 PNEUMATICHE

DATI TECNICI	1/8"	1/4"	1/2"
Pressione di funzionamento	Vuoto ÷ 10 bar		
Pressione minima di azionamento	2.5 bar		
• monostabile	1 bar		
• bistabile	-10° ÷ +60°C		
Temperatura di funzionamento	5 mm	7.5 mm	15 mm
Diametro nominale	121.43	264.26	971.43
Conduttanza C [NI/min · bar]	0.32 bar/bar	0.27 bar/bar	0.43 bar/bar
Rapporto critico b	400 NI/min	750 NI/min	3200 NI/min
Portata a 6 bar ΔP 0.5 bar	550 NI/min	1100 NI/min	4600 NI/min
Portata a 6 bar ΔP 1 bar	6ms/15ms	7ms/15ms	16ms/46ms
TRA / TRR monostabile a 6 bar	7ms/7ms	7ms/7ms	16ms/16ms
TRA / TRR bistabile a 6 bar			





### CHIAVI DI CODIFICA

P	N	V	2	3	P	N	S	N	C
FAMIGLIA	DIMENSIONE	FUNZIONE	AZION. 14		RIAZ. 12		ULTERIORE DESCR.		
PNV pneumatiche	2 1/8"	3 3/2	PN pneumatico		S	molla meccanica	OO	5/2	
	3 1/4"	5 5/2			B	bistabile	NC	norm. chiusa	
	4 1/2"	6 5/3			D	differenziale	NO	norm. aperta	
					O	stabile per 5/3	CC	centri chiusi	
					A	molla pneumomeccanica*	OC	centri aperti	
							PC	centri in press.	

## VALVOLE SERIE 70 1/8" PNEUMATICHE

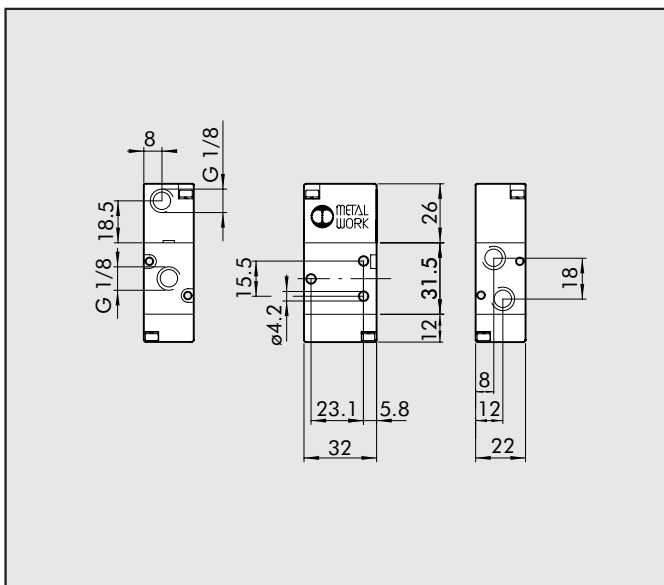
### MONOSTABILE 3/2 NO 1/8"



Simbolo	Sigla	Codice	Peso [g]
	PNV 23 PNS NO	7010010400	82

### MONOSTABILE 3/2 NC 1/8"

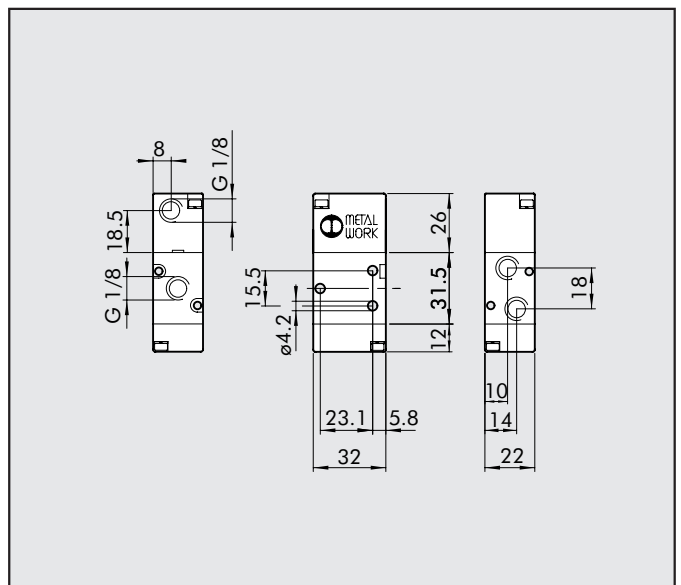

Simbolo	Sigla	Codice	Peso [g]
	PNV 23 PNS NC	7010010200	82

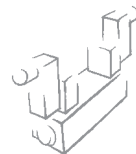

### MONOSTABILE 5/2 1/8"

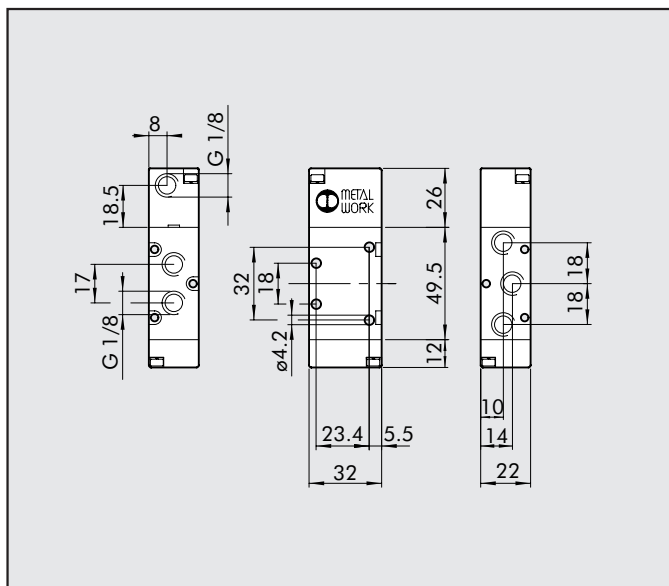

Simbolo	Sigla	Codice	Peso [g]
→	PNV 25 PNS OO	7010011100	108

### BISTABILE 5/2 1/8"

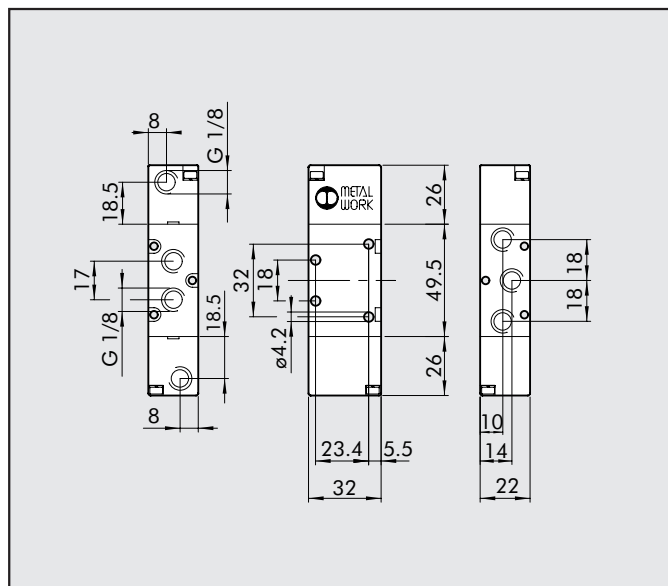

Simbolo	Sigla	Codice	Peso [g]
→	PNV 25 PNB OO	7010011200	122
→	PNV 25 PND OO	7010011300	128

### BISTABILE 3/2 1/8"

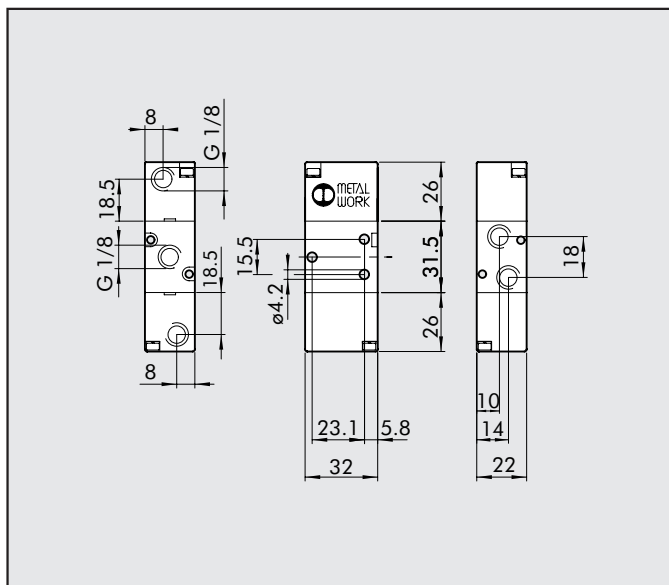

Simbolo	Sigla	Codice	Peso [g]
→	PNV 23 PNB OO	7010010100	96

### MONOSTABILE 5/3 1/8"

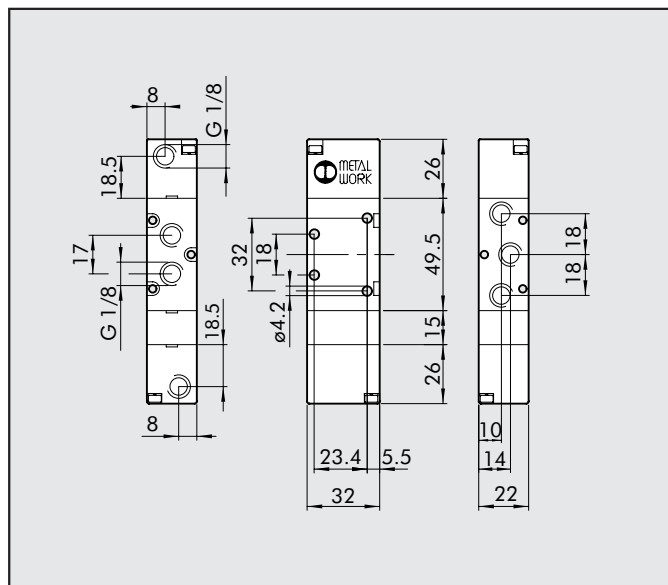

Simbolo	Sigla	Codice	Peso [g]
→	PNV 26 PNS CC	7010012100	150
→	PNV 26 PNS OC	7010012200	150
→	PNV 26 PNS PC	7010012300	150

# VALVOLE SERIE 70 1/4" PNEUMATICHE

## MONOSTABILE 3/2 NO 1/4"

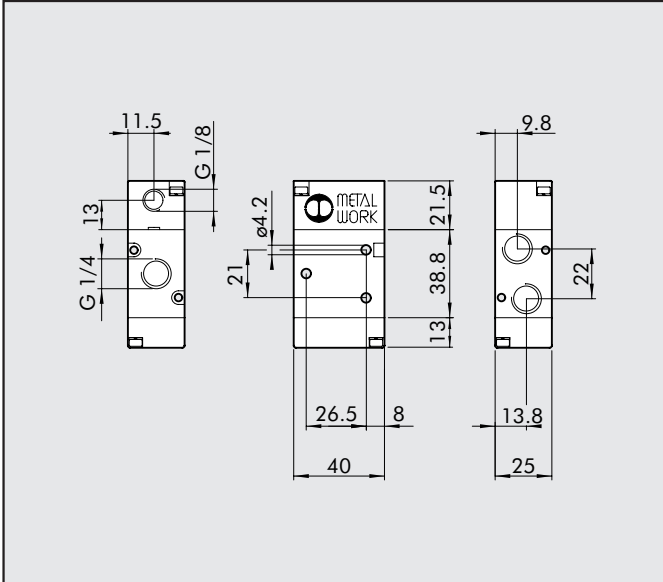

Simbolo	Sigla	Codice	Peso [g]
→ 	PNV 33 PNS NO	7020010400	124

## MONOSTABILE 3/2 NC 1/4"

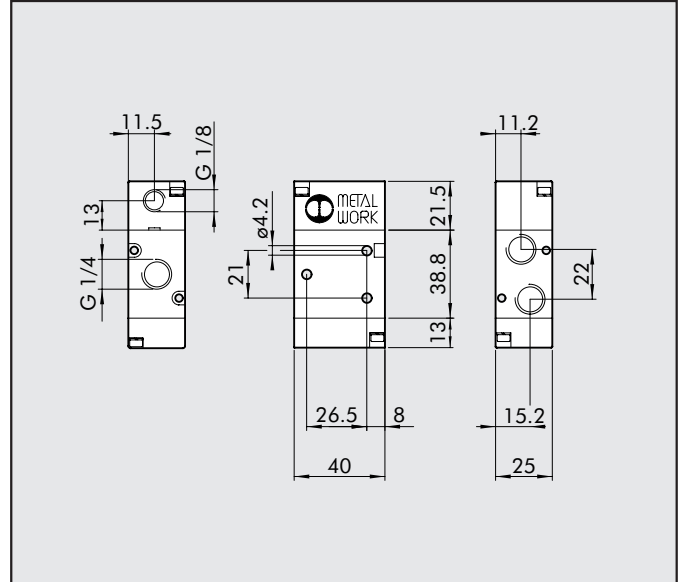

Simbolo	Sigla	Codice	Peso [g]
→ 	PNV 33 PNS NC	7020010200	122

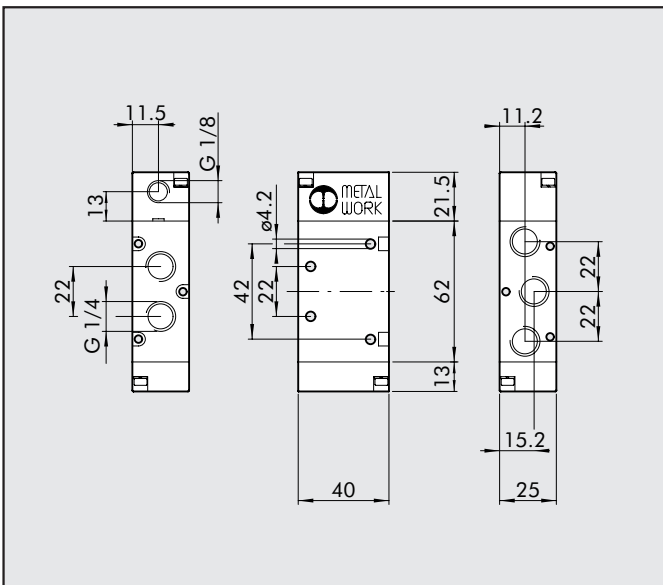

## MONOSTABILE 5/2 1/4"

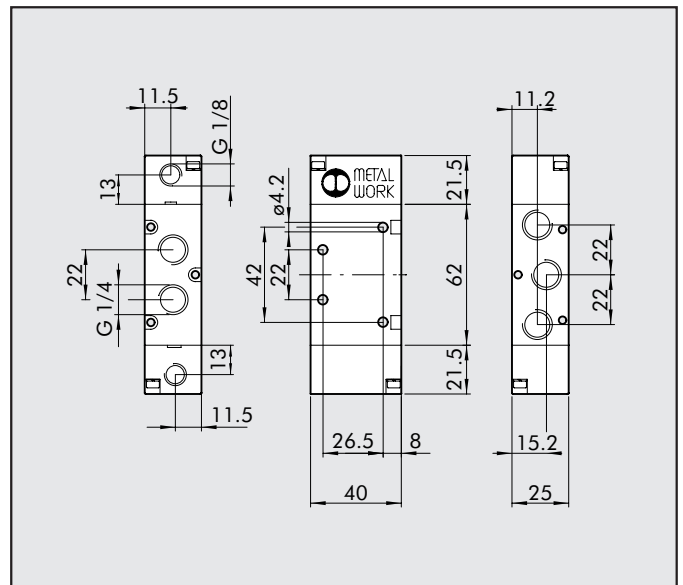

Simbolo	Sigla	Codice	Peso [g]
→ 	PNV 35 PNS OO	7020011100	174

## BISTABILE 5/2 1/4"



Simbolo	Sigla	Codice	Peso [g]
→ 	PNV 35 PNB OO	7020011200	174
→ 	PNV 35 PND OO	7020011300	198

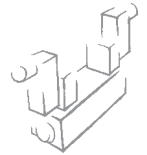

**BISTABILE 3/2 1/4"**

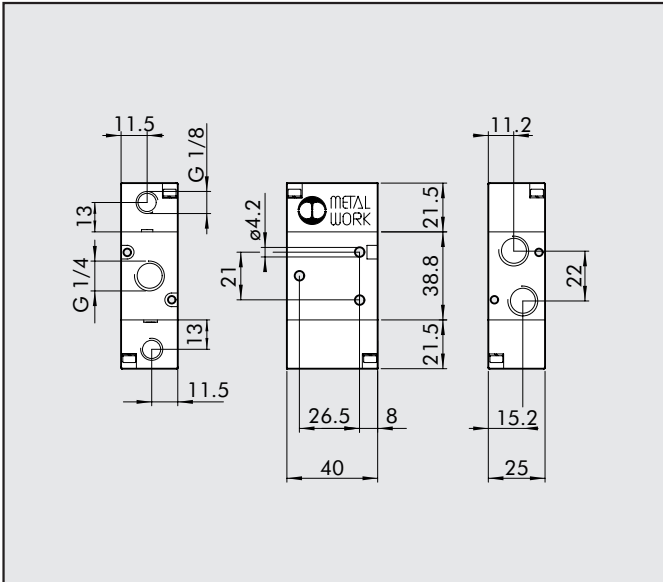

Simbolo	Sigla	Codice	Peso [g]
	PNV 33 PNB OO	7020010100	134

**MONOSTABILE 5/3 1/4"**

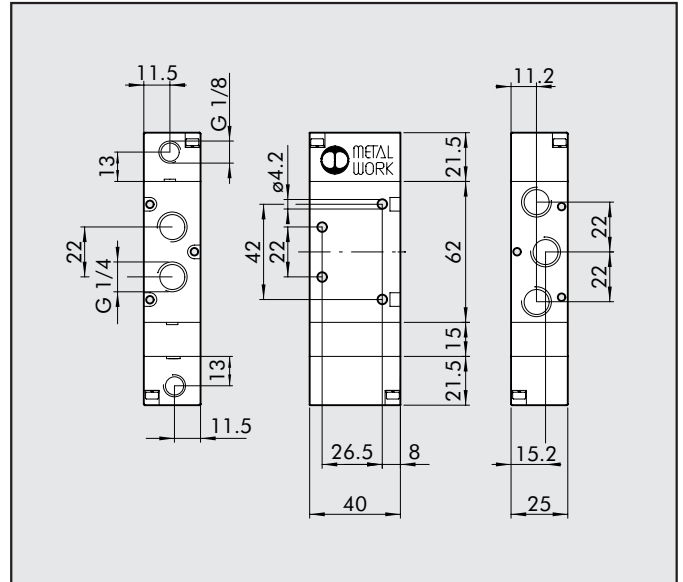

Simbolo	Sigla	Codice	Peso [g]
	PNV 36 PNS CC	7020012100	124
	PNV 36 PNS OC	7020012200	124
	PNV 36 PNS PC	7020012300	124

**NOTE**

Blank area for notes.

# VALVOLE SERIE 70 1/2" PNEUMATICHE

## MONOSTABILE 3/2 NO 1/2"

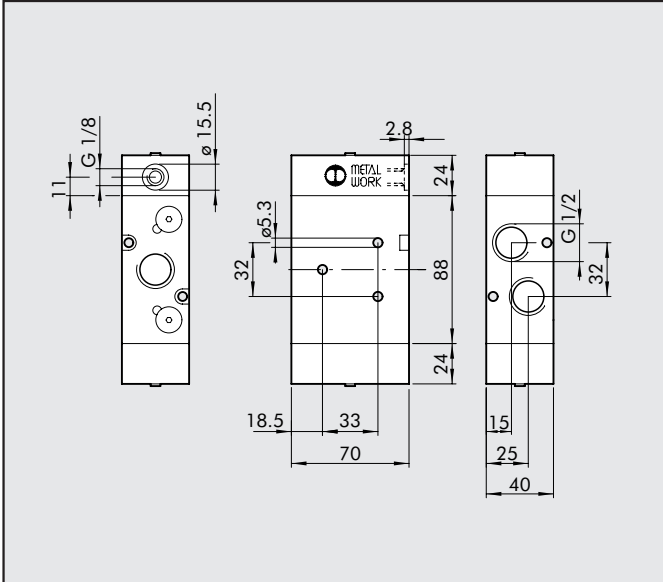

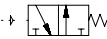
Simbolo	Sigla	Codice	Peso [g]
	PNV 43 PNS NO	7030010400	905

## MONOSTABILE 3/2 NC 1/2"

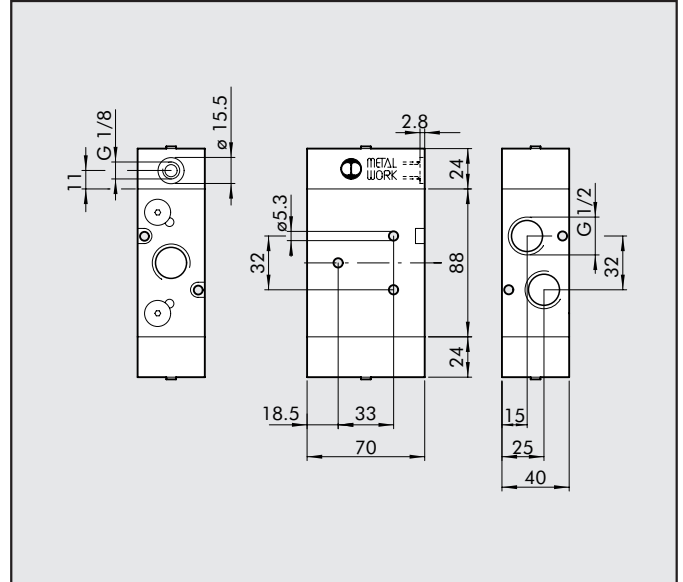

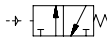
Simbolo	Sigla	Codice	Peso [g]
	PNV 43 PNS NC	7030010200	905

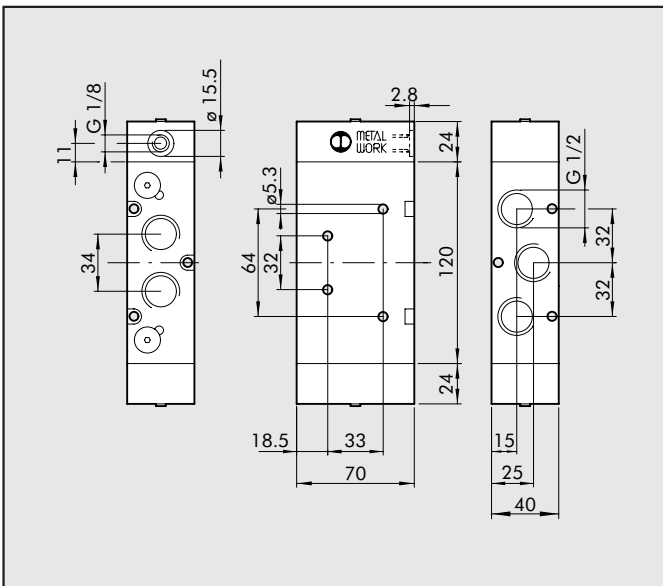

## MONOSTABILE 5/2 1/2"

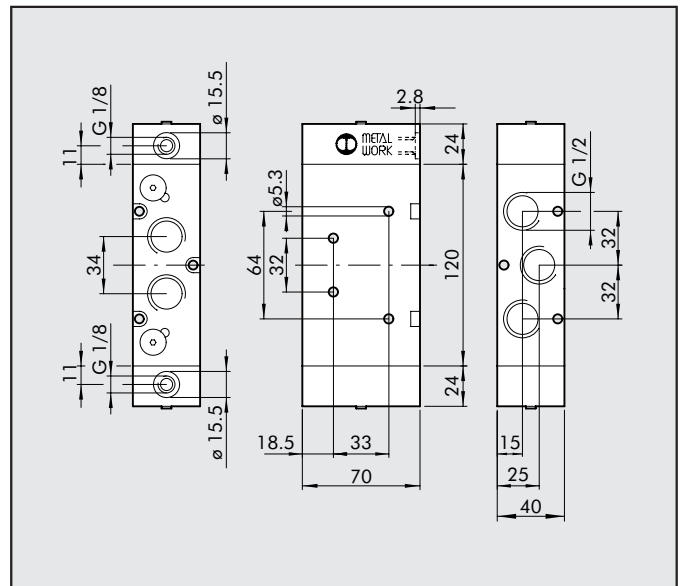

Simbolo	Sigla	Codice	Peso [g]
	PNV 45 PNS OO	7030011100	1090

## BISTABILE 5/2 1/2"



Simbolo	Sigla	Codice	Peso [g]
	PNV 45 PNB OO	7030011200	1077
	PNV 45 PND OO	7030011300	1090

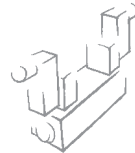

**BISTABILE 3/2 1/2"**

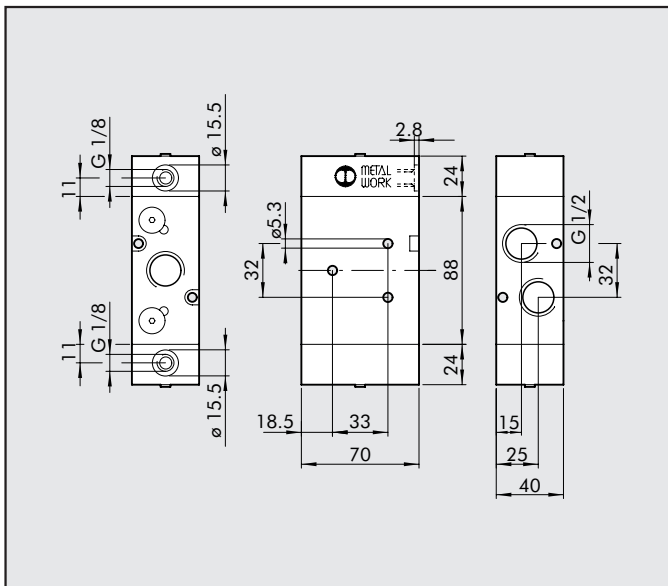

Simbolo	Sigla	Codice	Peso [g]
	PNV 43 PNB OO	7030010100	921

**MONOSTABILE 5/3 1/2"**

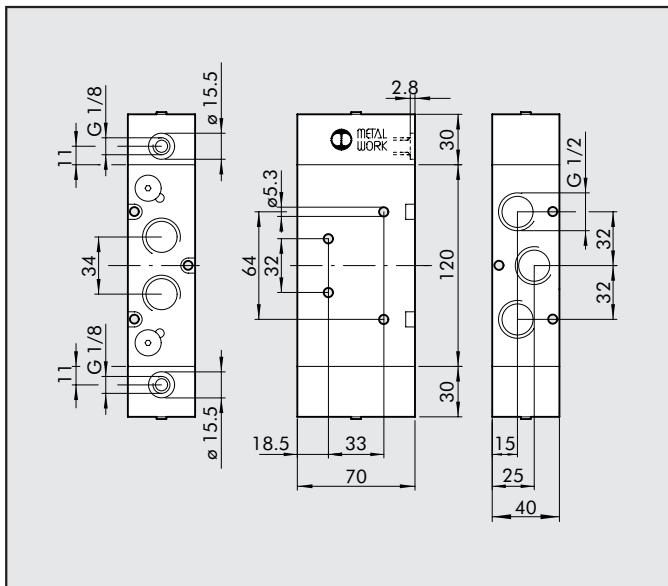

Simbolo	Sigla	Codice	Peso [g]
	PNV 46 PNS CC	7030012100	1200
	PNV 46 PNS OC	7030012200	1194
	PNV 46 PNS PC	7030012300	1196

**NOTE**

Blank area for notes.